

YOKOGAWA 

# DL1700E Series

DL1720E/DL1735E/DL1740E/DL1740EL  
Digital Oscilloscopes



*Signal Explorer*

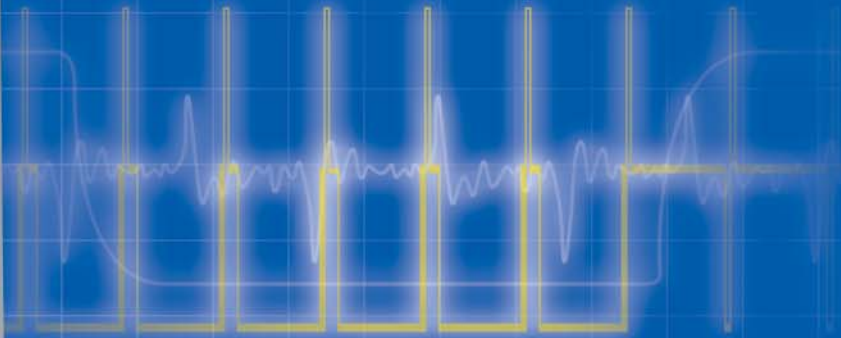

## DL1740EL

- Up to 1 GS/s, 8 MW Memory
- 350MHz Analog Bandwidth : DL1735E  
500MHz Analog Bandwidth : DL1720E, DL1740E, DL1740EL
- PC Card Interface
- USB Storage
- I<sup>2</sup>C & SPI Bus Trigger and Analysis

350MHz Analog Bandwidth

## DL1735E

**NEW!!**



**1GS/s**

Max. Sampling Rate

**8MW**

Max. Memory

**3-Year  
Warranty**

Bulletin 7017-40E

# DL1700E Series

**A4 size footprint**  
**Compact, space-saving form with**  
**350MHz and 500MHz bandwidth and Max.8MW memory**

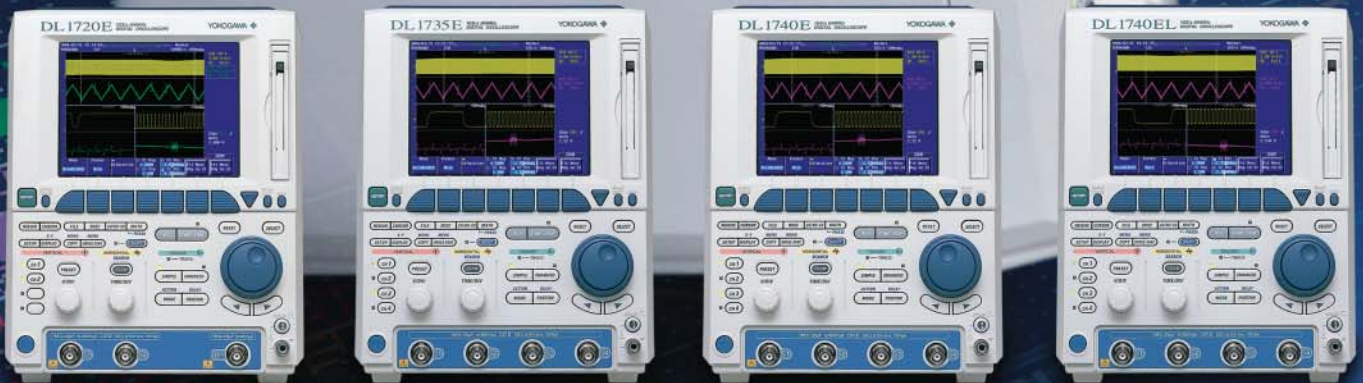

## High Performance at a great price

- **Maximum Sampling Rate**  
 1GS/s: Real-time sampling  
 100GS/s: Repetitive sampling
- **Bandwidth**  
 350MHz : DL1735E  
 500MHz : DL1720E, DL1740E, DL1740EL
- **Maximum Record Length**  
 DL1740EL: 8 Mwords (8 times longer <sup>1)</sup>)  
 DL1735E, DL1740E:  
 2 Mwords (2 times longer <sup>1)</sup>)  
 DL1720E: 1 Mword

1. When compared with the previous model of the DL1740

## Various supporting functions for your measurements

- **PC Card Interface (Type II)**  
 (or select floppy disk for removable media type)
- **USB Storage and USB Peripherals**  
 Supports USB memory devices (flash memory, hard disk drive, MO drive, etc.)  
 Supports a USB mouse, keyboard, or printer
- **Built-In Printer (Optional)**
- **Ethernet Function (Optional)**  
 Web Server, FTP server, and network printing

## Special functions for specific applications

- **I<sup>2</sup>C and SPI Bus Trigger and Analysis (Optional)**
- **HDTV Trigger**

### DL1700E Series Lineup

Model	DL1720E	DL1735E	DL1740E	DL1740EL
Item	701715	701725	701730	701740
Analog input channels	2	4	4	4
Max. Sampling rate	1GS/s			
Bandwidth	500MHz	350MHz	500MHz	500MHz
Max. Record length	1MW/ch	2MW/ch	2MW/ch	8MW/ch

**HDMI™**  
HIGH DEFINITION MULTIMEDIA INTERFACE

The DL1700E series with the I<sup>2</sup>C analysis function are officially accredited for HDMI<sup>®1</sup> compliance testing (DDC<sup>®2</sup> protocol analysis).

<sup>1</sup>: High-Definition Multimedia Interface  
<sup>2</sup>: Display Data Channel

## Easily and Accurately Capture Increasingly Complex Signals

### Accurately Capture and Observe Waveforms with the 8 Mword Long Memory and Easy Zoom Function

Even some oscilloscopes with high sampling rates may not be able to accurately capture waveforms if the memory size is not large enough for the required monitoring period. This limitation is due to the necessary drop in sampling rate, which occurs if the recording memory is not long enough. A larger recording memory not only increases the monitoring time, but also enables users to maintain a high sampling rate thus ensuring accurate waveform representation. In addition, the zoom function can be used to simultaneously view enlarged images on one or two segments of a waveform captured in the large memory.

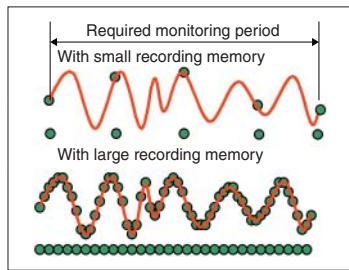

### All-Points Display and Fast Screen Updates Make Sure You Won't Miss Abnormal Signals

When working with data captured in the large recording memory, the amount of information appearing on the display varies greatly depending on how the data are presented. The differences occur depending on whether you choose to display all points in a captured waveform, or just major values, such as maximum and minimum values, in a given segment on the waveform. The DL1700E Series provides fast screen updating in all-points display mode, so you won't miss abnormal phenomena or have slow responses to instrument controls.

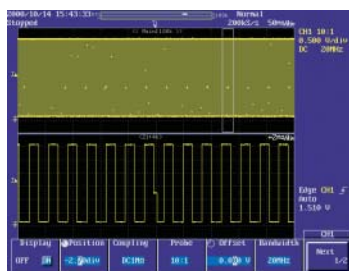

All-points display

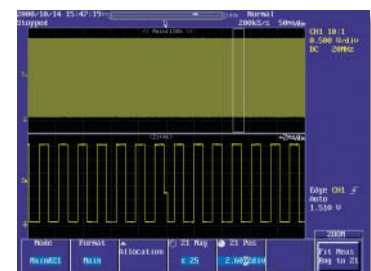

Conventional compression display

## Easily Find and Display Desired Date from Large Amounts of Data

### Smart Search Function for Effective Access to the Data You Need

"I want to find the serial data with a particular serial pattern", "I need to search for surge pulses of less than 30 ns", "I want to only extract waveforms that occasionally overshoot by an excessive amount".....As data volume increases, it becomes more important to be able to search for target phenomena efficiently. The Smart Search function automatically detects serial patterns, pulse widths, rising edges, falling edges, and other phenomena in the captured waveform data. These phenomena are then displayed in the zoom screen. Smart Search will significantly improve the efficiency of your development and evaluation work.

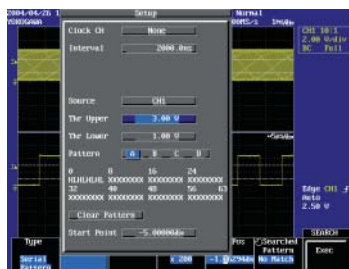

Serial pattern search setup

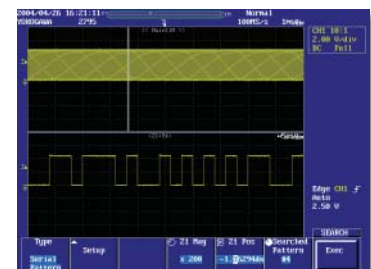

Serial pattern search results

### When an abnormal signal is displayed on the screen, does it disappear before you can press the STOP key?

#### History Memory

The history memory function divides the large recording memory into a number of blocks and automatically saves up to 2048 previously captured waveforms. Increase the number of screens saved to history memory by setting a shorter record length.

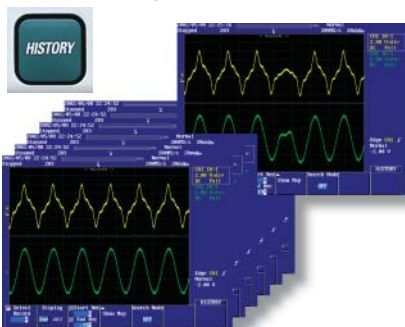

#### History Search

The history search function is useful for quickly finding abnormal waveforms in the large amounts of waveform data stored in history memory. This function lets you automatically search for desired waveforms based on whether or not a signal passes through a user-defined area on the screen. You can also conduct searches based on waveform parameters.

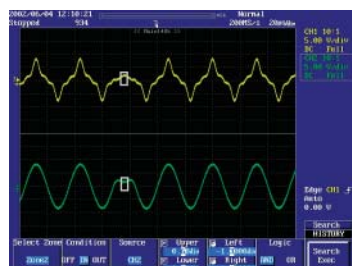

#### History Statistics

Calculates statistical information based on the parameter values for waveforms stored in history memory. This function calculates and displays a parameter's maximum value, minimum value, average value, and standard deviation. You can check the parameters for every waveform in history memory.

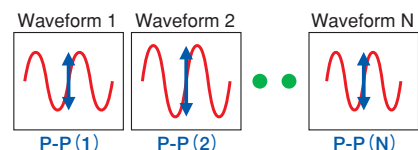

Measure Parameter List		
	P-P(C1)	P-P(C2)
#00023	1.1312500	1.250000
#00024	5.208330	1.041670
#00025	10.62500	1.041670
#00026	9.166670	0.333300
#00027	6.458330	1.458330
#00028	12.70830	0.333300
#00029	4.791670	1.041670

# A Variety of Functions Offer the Best Solutions for Diverse Measurement Needs

## Measuring Periodically Fluctuating Amplitudes

### Cycle Statistics

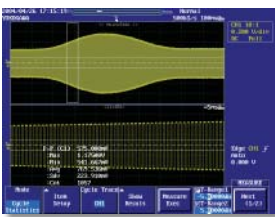

Automatically calculates the maximum value, minimum value, average value, and standard deviation of selected waveform parameters for each period of a signal. You can even find the period corresponding to the calculated maximum and minimum values and display that period in the zoom window. In some applications, like with a PWM (pulse width

modulation) control signal, you may need to determine information about each waveform period for long amounts of time. The DL1700E Series with its long memory, lets you analyze a long waveform, period-by-period, based on the period of a reference signal.

## How can I quickly count a large number of pulses in a waveform?

### Pulse Count

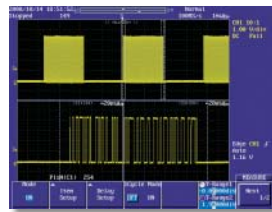

Automatically counts the number of pulses in the waveform data between cursors. The threshold level for recognizing a single pulse is user-definable, so you can reliably compute pulses even in signals with unstable levels. With the DL1700E Series, you'll never again have to manually count pulses on screen or on a stack of printouts.

## Envelope and Roll modes for simultaneously observing both slow and fast signals

Envelope mode always captures signals at the highest sampling rate, irrespective of the time-axis setting. This mode is effective when observing high-frequency noise superposed on a slow signal. Roll mode allows you to observe signals on the screen in much the same way as you record them on a chart recorder. When in normal mode, you can set the sampling rate as high as 2 MS/s for roll mode. In addition, you can have a roll-mode view of signals in the envelope mode.



Roll-mode View in Normal Mode



Roll-mode View in Envelope Mode

## Simple and Enhanced Triggers for Reliable Capturing of a Variety of Waveforms

### Simple and Enhanced Triggers

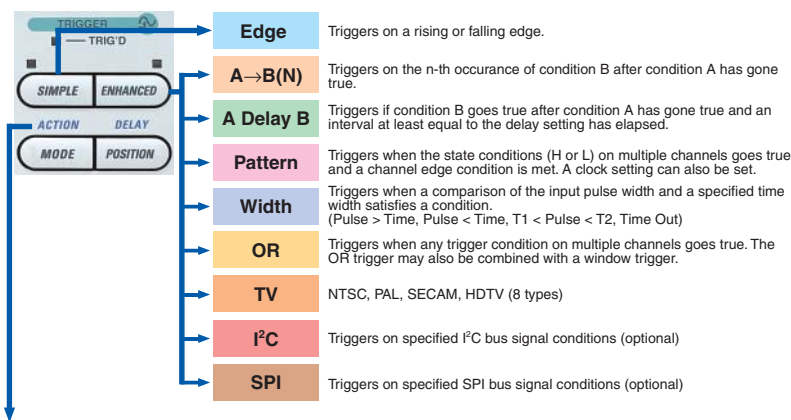

### Action-On Trigger

With the action-on trigger, a specified action is automatically executed each time the trigger is activated. You can use the trigger for a variety of actions, such as automatically saving captured data. The action-on trigger is useful for purposes such as collecting data in continuous tests.

## GO/NO GO Judgment

— Automatic Waveform Discrimination —

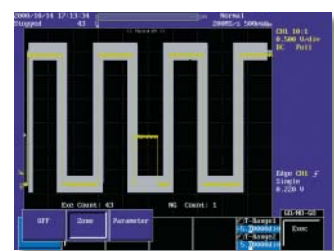

Select zones or parameters for the waveform of an acquired signal. The DL1700E judges the signal being measured and automatically takes action. Actions you can choose from include: outputting screen images data to the destination specified in the Copy Setup menu, saving waveform data in the medium specified in the File menu, sounding the buzzer, and sending e-mail.

## Dedicated I<sup>2</sup>C Bus Trigger and Analysis Function (Optional)

I<sup>2</sup>C bus signals (SCL and SDA) used extensively in home electronics such as televisions and video cameras and in communications equipment such as mobile phones can be captured with specialized triggers, analyzed, and displayed as waveforms.

### I<sup>2</sup>C Bus Analysis Function

Triggers can be activated using conditions such as Start, Non-Ack, Address pattern, and Data pattern. These dedicated I<sup>2</sup>C bus triggers can also be combined with other analog signals to activate additional triggers.

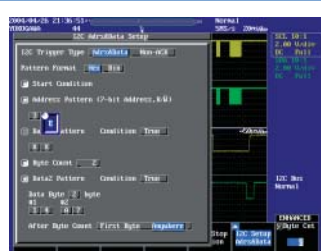

I<sup>2</sup>C bus trigger setup menu

### I<sup>2</sup>C Bus Analysis Function

Captured waveforms can be analyzed in a time series manner, and the analysis results displayed in a list.

When an analysis result is selected with the cursor, the corresponding waveform is automatically enlarged in the zoom area. Two pairs of I<sup>2</sup>C busses can be input at the same time, then analysis can be performed alternately on either bus.



I<sup>2</sup>C bus analysis results

## Dedicated SPI Bus Trigger and Analysis Function (Optional)

The SPI data bus is a synchronous 8-bit serial bus used widely for inter-IC and data communications in embedded systems. SPI bus signals can be captured using the DL1700E dedicated triggers and the waveforms can be analyzed and displayed on the screen.

### SPI Bus Trigger Function

Triggers can be activated by comparing each byte of MOSI (master output slave input) and MISO (master input slave output) data with specified conditions. You can trigger on user-defined strings of data from 1 to 8 bytes long.

### SPI Bus Analysis Function

Data analysis results and SS (slave select) bits can be displayed in a list together with the waveforms. You can perform a high speed search for a specified MOSI or MISO data pattern (of 1 to 8 bytes) from within all of the captured data.



SPI bus analysis setting screen

## Connection with a Wide Range of Peripherals such as PC, Printer

### USB

#### Peripheral Device Connections

- USB compatible flash memory, hard drives, or MO drives can be connected to easily save waveform data and screen images.
- The DL1700E Series can be completely controlled using a USB mouse.
- File names can be entered using a USB keyboard.
- Connect a USB printer for color printouts.



#### PC Connection

- You can create a PC program to remotely control the DL1700E via USB. This is similar to how you would control operations via GP-IB.

### Ethernet

#### Web Server

With an Ethernet connection, you can perform various functions using Internet Explorer.

#### • FTP

Easily copy and paste files from the DL1700E's internal storage devices to connected PC or network drive. The internal storage device functions as one of your PC file servers.

#### • Data Capture

Perform actions such as waveform monitoring, uploading settings, and starting/stopping measurements.

#### • Measurement Trend

Automatically opens Excel, then periodically downloads waveform parameter values and graphs them. Easily monitor parameter trends during extended-period measurements.

#### • Printing on a Network Printer

The screen image can be printed on a network printer in the same way as you would print to the internal printer or a USB printer.

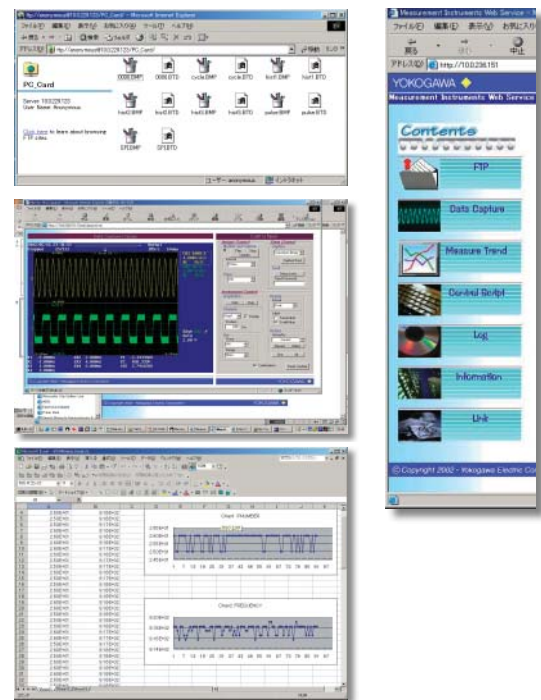

## Easily and Quickly Output Images and Data to a Variety of Devices

The COPY key lets you print screenshots to the built-in printer, a USB printer, or a network printer.



By simply pressing IMAGE SAVE key, you can easily and quickly save screen image data to the PC card, USB flash memory, MO, or USB hard disk media. Screen image formats include BMP, TIFF, PS, PNG, or JPEG. Thumbnail images make previewing your captured images simple. The thumbnail appears together with the file name, allowing you to confirm, delete, or make spot changes to the image file name.



USB flash memory



USB MO

## Rear Panel

### USB-PC Connector

Compliant with USB Rev. 1.1

### USB Peripheral Connectors

Type A connectors: 2  
Compliant with USB Rev. 1.1  
Accepts a USB flash memory device, hard drive, MO drive, mouse, keyboard, or printer.

### External Trigger Input/External Clock Input/Trigger Gate Input (701715 is on the front panel)

Inputs DC to 100 MHz signal for external triggering (external trigger input).  
Inputs clock signal from 40 Hz to 20 MHz from exterior (external clock).  
Trigger occurrence can be controlled using external signal (trigger gate input).

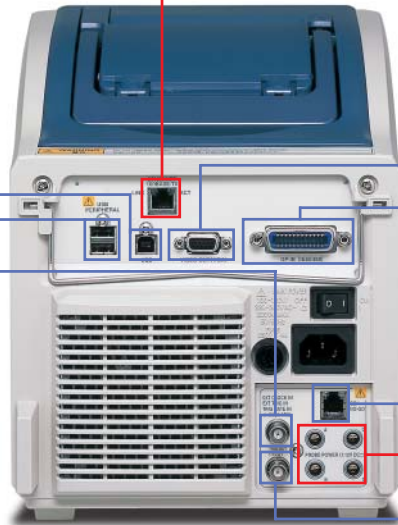

### Ethernet (Optional)

100 BASE-TX/10-BASE-T compliant  
Lets you take advantage of Web Server and WebDAV functions.

### RGB Video Signal Output Connector

Outputs a video signal for viewing waveforms on an external monitor.

### GP-IB

### GO/NO-GO Output Terminal

Using the GO/NO-GO function, you can output waveform judgment results as TTL level signals.

### Probe Power Terminal (Optional) (Two outputs on the 701715)

Power output terminals for accessory probes.

### Trigger Output

Outputs TTL level trigger signal.

## Software

### Xviewer (701992)

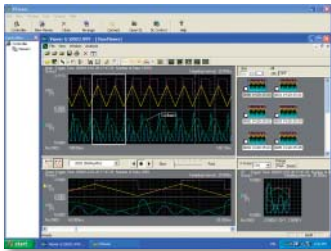

Xviewer is a PC software application designed to work with Yokogawa's DL series digital oscilloscopes and the DL750 series ScopeCorders. Xviewer allows you to display DL-acquired waveform data (using the "Viewer" function), perform file transfers, and control DL series instruments remotely.

You can download a trial version of Xviewer from YOKOGAWA's web site at:  
<http://www.yokogawa.com/tm/701992/>

### MATLAB tool kit (701991)

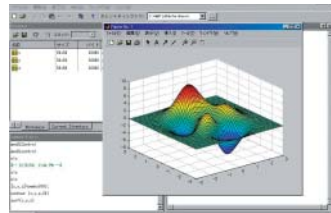

The MATLAB tool kit for the DL series is a plug-in for MATALAB software. The toolkit can be used to control supported DL series instruments using MATLAB or to acquire data from a DL series instrument for use in MATLAB via a communication interface (GP-IB, USB, Ethernet).

You can download a trial version of MATLAB tool kit from YOKOGAWA's web site at:  
<http://www.yokogawa.com/tm/701991/>

## Accessories



**Miniature passive probe (701941)**  
500MHz bandwidth, 1.2m long  
Standard accessories: Basic Accessories set B9852HF-see right.

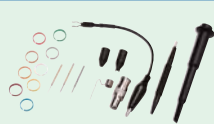

**Basic accessories set for the 701941 probe(B9852HF)**  
11 accessories are included in this set. \*2



**900 MHz FET probe (700939)**  
Attenuation ratio: 1/10 with 50 Ω load  
Input voltage range: ±10 V



**50 MHz current probe (701933)**  
Input range: 30Arms



**100 MHz current probe (701932)**  
Input range: 30 Arms



**10 MHz current probe (701930)**  
Input range: 150 Arms



**100 MHz differential probe (700924)**  
Attenuation ratio: Can be switched between 1/100 and 1/1000  
Max. differential allowed voltage: ±350 V/(1/100), ±1400 V/(1/1000)



**100 MHz differential probe (701921)**  
Attenuation ratio: Can be switched between 1/10 and 1/100  
Max. differential allowed voltage: ±70 V/(1/10), ±700 V/(1/100)



**200 MHz differential probe (701922)**  
Attenuation ratio: 1/10 with 50 Ω load  
Max. differential allowed voltage: ±20 V



**500 MHz differential probe (701920)**  
Attenuation ratio: 1/10 with 50 Ω load  
Max. differential allowed voltage: ±12 V

\*1: 701941 probes including the basic accessories set are included with the main unit when the /EX2, /EX4 options are specified.

\*2: The B9852HF contains the following eleven(11) kinds of accessories.

(Insulation cap, IC cap, BNC adapter, Rigid tip, Spring tip (Ø: 0.80 mm), Spring tip (Ø: 0.38 mm), Ground spring, Adjustment tool, Pincher tip, Standard ground lead, Color coding rings)

## Main Specifications

Basic Specifications	
Input channels	4 (701725, 701730, 701740) 2 (701715)
Input coupling	AC 1 M $\Omega$ , DC 1 M $\Omega$ , DC 50 $\Omega$ , GND
Input impedance	1 M $\Omega$ ±1.0%, 50 $\Omega$ ±1.0%
Voltage axis sensitivity setting Range	For 1 M $\Omega$ input: 2 mV/div to 10 V/div (steps of 1, 2, or 5) For 50 $\Omega$ input: 2 mV/div to 1 V/div (steps of 1, 2, or 5)
Maximum input voltage	For 1 M $\Omega$ input (frequency of 1 kHz or less): 400 V (DC + ACpeak)(282 Vrms CAT II) For 50 $\Omega$ input: 5 Vrms or 10 Vpeak (and neither are exceeded)
Frequency characteristics <sup>1</sup>	701715, 701730, 701740 For 1 M $\Omega$ input (using passive probe model 700988; specified at probe tip): 10 V/div to 10 mV/div: DC to 400 MHz (500 MHz <sup>4</sup> ) 5 mV/div to 2 mV/div: DC to 300 MHz (400 MHz <sup>4</sup> ) For 50 $\Omega$ input: 1 V/div to 10 mV/div: DC to 500 MHz 5 mV/div to 2 mV/div: DC to 400 MHz 701725 For 1 M $\Omega$ input (using passive probe model 700988; specified at probe tip): 10 V/div to 10 mV/div: DC to 350 MHz (350 MHz <sup>4</sup> ) 5 mV/div to 2 mV/div: DC to 250 MHz (250 MHz <sup>4</sup> ) For 50 $\Omega$ input: 1 V/div to 10 mV/div: DC to 350 MHz 5 mV/div to 2 mV/div: DC to 250 MHz 701725, 701730 For 1 M $\Omega$ input (using passive probe model 700988; specified at probe tip): 10 V/div to 10 mV/div: DC to 350 MHz (350 MHz <sup>4</sup> ) 5 mV/div to 2 mV/div: DC to 250 MHz (250 MHz <sup>4</sup> ) For 50 $\Omega$ input: 1 V/div to 10 mV/div: DC to 350 MHz 5 mV/div to 2 mV/div: DC to 250 MHz
A/D conversion resolution	8 bits (24 LSB/div)
Maximum sampling rate	Real-time sampling mode Interleave mode ON: 1 GS/s <sup>2</sup> Interleave mode OFF: 500 MS/s Repetitive sampling mode: 100 GS/s
Maximum record length	701715 Interleave mode ON: 1 MW/CH <sup>2</sup> Interleave mode OFF: 500 kW/CH 701725, 701730 Interleave mode ON: 2 MW/CH <sup>2</sup> Interleave mode OFF: 1 MW/CH 701740 Interleave mode ON: 8 MW/CH <sup>2</sup> Interleave mode OFF: 4 MW/CH
DC accuracy <sup>1</sup>	±(1.5% of 8 div + offset voltage accuracy)
Offset voltage axis accuracy <sup>1</sup>	2 mV/div to 50 mV/div: ±(1% of setting + 0.2 mV) 100 mV/div to 500 mV/div: ±(1% of setting + 2 mV) 1 V/div to 10 V/div: ±(1% of setting + 20 mV)
Time axis setting range	1 ns/div to 50 s/div (for record length of 10 kW or greater) 1 ns/div to 5 s/div (for record length of 1 kW)
Time base accuracy <sup>1</sup>	±0.005%
External clock input	Input frequency range: 40 Hz to 20 MHz (continuous clock signal only)
Trigger	
Trigger modes	Auto, Auto Level, Normal, Single, Single (N)
Trigger source	CH1 to CH4 (or CH1 to CH2 for the 701715), LINE (connected commercial power signal), EXT (signal input from the EXT TRIG IN terminal)
Trigger types	Edge, A->B(N), A Delay B, OR, Pattern, Pulse width, TV, I <sup>2</sup> C (optional), SPI (optional)
Display	
Screen updating rate	Maximum 60 times per second (for 10 kW all-points display) Maximum 30 times per second (for 1 MW all-points display)
Display	6.4-inch color TFT liquid crystal display
* Note that an LCD may contain some pixels which always glow or never glow or may have uneven brightness due to its characteristics. These are not indications of an equipment problem.	
Functions	
• <b>Vertical/Horizontal Axis Setting</b>	
Input filter	Band limit of 100 MHz or 20 MHz can be set independently on each channel (CH1 to CH4, or CH1 to CH2 for the 701715)
Roll mode	The roll display mode is enabled when the trigger mode is auto, auto level, or single and the time axis is as follows: For record lengths of 1 MW or less: 50 ms/div-50 s/div (or 50 ms/div-50 s/div in the case of 1 kW only) For a record length of 2 MW: 100 ms/div-50 s/div For a record length of 4 MW: 200 ms/div-50 s/div For a record length of 8 MW: 500 ms/div-50 s/div
• <b>Waveform Acquisition/Display Functions</b>	
Acquisition modes	Normal, Envelope, Averaging, Box Average
Zoom	Zoom in on displayed waveforms along the time axis (one or two zoom windows with separate enlargement ratios)
X-Y display	Two X-Y waveform displays are available, XY1 and XY2 (only XY1 is available on the 701715).
• <b>Analysis Function</b>	
Search and Zoom function	Edge, serial pattern, parallel pattern, pulse width, auto scroll, I <sup>2</sup> C (optional), SPI (optional)
History search functions	Zone, parameter
Cursor measurements	Horizontal, Vertical, Marker, Degree, H&V
Automatic Measurement of	Waveform Parameters Function P-P, Max, Min, Avg, Rms, Sdev, High, Low, +OShot, -OShot, Int1TY, Int2TY, Int1XY, Int2XY, Freq, Period, Rise, Fall, +Width, -Width, Duty, Burst1, Burst2, Pulse, AvgFreq, AvgPeriod, Delay (between channels) Also, the following statistical processes can be performed Source items: The above parameters Statistics: Min, Max, Avg, Cnt, Sdv Statistical mode: Normal, Cycle, History

Computation Functions	+, -, x, binary computation, inversion, differentiation, integration, power spectrum (FFT)
GO/NO-GO judgment	Evaluation based on automatically measured waveform parameter values and waveform zones
• <b>Output Screen Image Data</b>	
Built-in printer (optional)	Paper width: 112 mm Output formats: Normal, Long
External printer	Outputs to an external printer via the USB PERIPHERAL terminal or Ethernet <sup>3</sup> . Supports the following printer formats: ESC/P, ESC/P2, ESC/PR <sup>5</sup> , LIPS3, PCL5, BJ, PostScript (via Ethernet only <sup>3</sup> )
Floppy disk / PC card / Network Drive (via Ethernet <sup>3</sup> / USB Storage)	Output data formats: PostScript, TIFF, BMP, JPEG, PNG

I <sup>2</sup> C Bus Analysis Function (Option for the DL1735E, DL1740E and DL1740EL)	
• <b>Applicable Bus</b>	
I <sup>2</sup> C bus	Bus transfer rate: Up to 3.4 Mbit/s Address mode: 7 bit
SM bus	System Management Bus compliant
• <b>Trigger Function</b>	
Trigger source	CH1: SCL CH2: SDA CH3, CH4: Analog signal input
Start Condition	Triggers on Start conditions
Address	Trigger on user-defined address
Data 1	Triggers on user-defined data byte immediately after address
Byte Count	Up to 9,999 can be specified
Data 2	Triggers on user-defined data byte after byte count has elapsed, up to 2 bytes can be specified
Non-ACK trigger	Triggers when no acknowledgment is given
Combination trigger	Analog signals on CH3 and CH4 can be combined with the I <sup>2</sup> C bus trigger.
• <b>Analysis Functions</b>	
Waveform & data display	Simultaneous display of data (hex display) and waveforms
Detailed data display	Time from a reference point, data (simultaneous display in binary and hex), and presence or absence of ACK
Number of analyzable data	Up to 40,000 bytes worth
Analysis channels	SCL: CH1, CH3 SDA: CH2, CH4 Enables switching of analysis between two pairs of busses

SPI Bus Analysis Function (Option for the DL1735E, DL1740E and DL1740EL)	
• <b>Trigger Functions</b>	
Trigger source	CH1: SCK CH2: MOSI CH3: MISO CH4: SS
Assertion of SS	Triggers on SS assertion
A Pattern	Triggers on user-defined MOSI data directly after SS assertion, up to 8 bytes can be specified
Byte Count	Up to 1,000 times can be specified
B Pattern	Triggers on user-defined data after byte count has elapsed, up to 8 bytes can be specified
• <b>Analysis Function</b>	
Waveform & data display	Simultaneous display of data (hex display) and waveforms
Detailed data display	Time from a reference point, data (binary or hex), and CS signal condition
Number of analyzable data	Up to 80,000 bytes worth
Analysis channels	CH1: Clock signal (SCK) CH2: Data1 (MOSI) CH3: Data2 (MISO) CH4: CS signal (SS)

Rear Panel I/O Section	
USB PERIPHERAL Interface	Compliant with USB Rev. 1.1 Accepts a USB compatible flash memory device, hard drive, MO drive, mouse, keyboard, or printer.
Computer interface	GP-IB, USB-PC connector (USB Rev 1.1 compliant), Ethernet (100BASE-TX/10BASE-T compliant, optional)
Signal I/O	External trigger input/external clock input/trigger gate input, trigger output, RGB video signal output (VGA), GO/NO-GO output
Probe power terminal (optional)	No. of terminals: 4 (701725, 701730, 701740) 2 (701715) Output voltage: ±12 V

General Specifications	
Rated supply voltage	100-120 VAC/220-240VAC (switches automatically)
Rated supply frequency	50/60 Hz
Maximum power consumption	200 VA
External dimensions	220 mm (W) × 265.8 mm (H) × 264.1 mm (D) (when the printer cover is closed; does not include handle and protrusions)
Weight	Approximately 5.5 kg (with all options) Approximately 5.4 kg (without options)
Operating temperature range	5-40°C

- 1: Measured value under standard operating conditions (below) after warming up the instrument, performing calibration, and setting the time base to internal clock.  
Standard operating conditions Ambient temperature: 23 ±2°C  
Ambient humidity: Humidity: 55 ±10% RH
- 2: When Interleave mode is ON, the number of available channels is reduced by half.
- 3: With the /C10 option
- 4: When using Miniature passive probe model 701941; specified at probe tip.
- 5: Available on firmware ver2.45 or later.

The specifications can be viewed at the following URL. <http://www.yokogawa.com/tm/DL1700E/>

## DL1720E, DL1735E, DL1740E, DL1740EL Model Number and Suffix Codes

Model	Suffix Code	Description
701715		DL1720E digital oscilloscope with 2 ch input, 500MHz analog bandwidth and maximum 1 MW memory
701725		DL1735E digital oscilloscope with 4 ch input, 350MHz analog bandwidth and maximum 2 MW memory
701730		DL1740E digital oscilloscope with 4 ch input 500MHz analog bandwidth and maximum 2 MW memory
701740		DL1740EL digital oscilloscope with 4 ch input 500MHz analog bandwidth and maximum 8 MW memory
Power cable	-D	UL and CSA standard
	-F	VDE standard
	-Q	BS standard
	-R	AS standard
	-H	GB standard
Internal storage drive	-J1	Floppy disk drive <sup>1</sup>
	-J3	PC card interface (type II) <sup>1</sup>
Options	/B5	Built-in printer
	/P2	Probe power for model 701715 <sup>2</sup>
	/P4	Probe power for models 701725, 701730 and 701740 <sup>2</sup>
	/C10	Ethernet interface
	/F5	I <sup>2</sup> C + SPI bus analysis function <sup>3</sup>
	/EX2	Attach two 701941 probes <sup>4</sup>
/EX4	Attach four 701941 probes <sup>5</sup>	

The instrument comes standard with passive probes (700988). Four probes are included with the 701730 and 701740, and two probes are included with the 701715.

1. One or the other must be selected.

2. Select /P2 for model 701715, or /P4 for models 701725, 701730 and 701740.

3. Option for models 701725, 701730 and 701740 only.

4. Option for model 701715 only. The 700988 probes are not included when this option is specified.

5. Option for models 701725, 701730, 701740 only. The 700988 probes are not included when this option is specified.

## Standard Accessories

Name	Quantity
Power cable	1
Passive probe (700988)	1 per channel
Power fuse	1
Front cover (transparent type)	1
Soft case for probe	1
Printer roll paper (when the /B5 option is specified)	1
User's manual (one set)	1

## Supplies

Name	Part number	Description	Order Quantity
Printer roll paper	B9850NX	30 meter roll (1 roll per package)	5
Passive probe	700988	10 M $\Omega$ (10:1), 400 MHz band, 1.5 m (1 probe per package)	1
Front cover	B9989FA	LCD, protects front panel	1

## Related Products



[Signal Explorer is a registered trademark of Yokogawa Electric Corporation.]

Microsoft, MS, Windows, and Internet Explorer are trademarks or registered trademarks of Microsoft Corporation in the US and other countries.

Ethernet is a registered trademark of Xerox Corporation.

MATLAB is a registered trademark of the Math Works, Inc in the US.

Other company names and product names appearing in this document are trademarks or registered trademarks of their respective companies.

## Accessories (Optional)

Name	Model	Description
FET probe	700939	900 MHz
Current probe	701933	DC to 50 MHz, 30 Arms
Current probe	701932	DC to 100 MHz, 30 Arms
Current probe	701930	DC to 10 MHz, 150 Arms
Current probe	701931	DC to 2 MHz, 500 Arms
Differential probe	700925	DC to 15 MHz
Differential probe	700924	DC to 100 MHz
Differential probe	701921	DC to 100 MHz
Differential probe	701922	DC to 200 MHz
Differential probe	701920	DC to 500 MHz
Miniature passive probe	701941	DC-500MHz bandwidth
Miniature passive probe	701942	10:1, 350 MHz, 3 m
100:1 probe	701944	100:1, 400 MHz, 1.2 m
100:1 probe	701945	100:1, 250 MHz, 3 m
Probe Stand	701919	Circular Base, with a flexible arm
Soft Carrying Case	701964	Three pockets are provided.
Hard Carrying Case	701950	Hard type Carrying Case

Note: Please see the Bulletin 7009-63E (DL series Accessories) for details.

## Exterior Dimensions

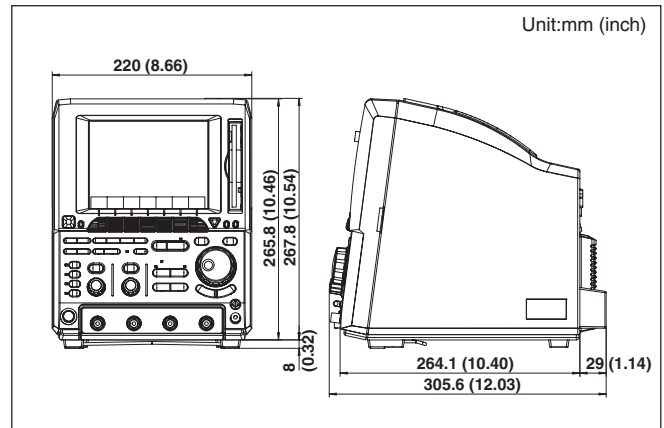

# YOKOGAWA

YOKOGAWA ELECTRIC CORPORATION  
Communication & Measurement Business Headquarters /Phone: (81)-422-52-6768, Fax: (81)-422-52-6624  
E-mail: tm@cs.jp.yokogawa.com

YOKOGAWA CORPORATION OF AMERICA Phone: (1)-770-253-7000, Fax: (1)-770-251-6427  
YOKOGAWA EUROPE B.V. Phone: (31)-33-4641858, Fax: (31)-33-4641859  
YOKOGAWA ENGINEERING ASIA PTE. LTD. Phone: (65)-62419933, Fax: (65)-62412606

Subject to change without notice.  
[Ed : 04/b] Copyright ©2004  
Printed in Japan, 707(KP)

### Yokogawa's Approach to Preserving the Global Environment

- Yokogawa's electrical products are developed and produced in facilities that have received ISO14001 approval.
- In order to protect the global environment, Yokogawa's electrical products are designed in accordance with Yokogawa's Environmentally Friendly Product Design Guidelines and Product Design Assessment Criteria.

### NOTICE

- Before operating the product, read the user's manual thoroughly for proper and safe operation.
- If this product is for use with a system requiring safeguards that directly involve personnel safety, please contact the Yokogawa sales offices.